

HENRY PARK PRIMARY SCHOOL
2025 END OF YEAR EXAMINATION
STANDARD SCIENCE
PRIMARY FOUR
BOOKLET A

Name: _____ ()

Class: Primary 4 ()

30 QUESTIONS

60 MARKS

TOTAL TIME FOR BOOKLETS A & B: 1 HOUR 45 MINUTES

INSTRUCTIONS TO CANDIDATES

1. Do not turn over this page until you are told to do so.
2. Follow all instructions carefully.
3. Answer all questions.

Marks for Booklet A: _____ / 60

Parent's Signature: _____

For each question from 1 to 30, four options are given. One of them is the correct answer. Make your choice (1, 2, 3 or 4). Shade the correct oval (1, 2, 3 or 4) on the Optical Answer Sheet. (60 marks)

- 1 Zoe learns that all living things need air, water and food to stay alive. Which set-up can she use to keep her grasshopper alive?

(1)

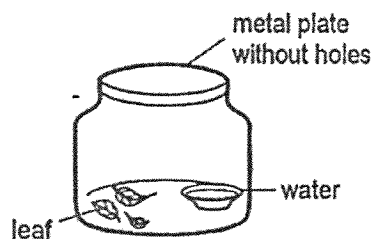

(2)

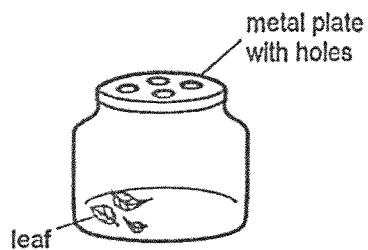

(3)

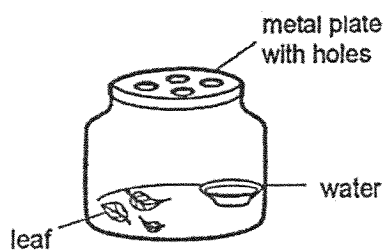

(4)

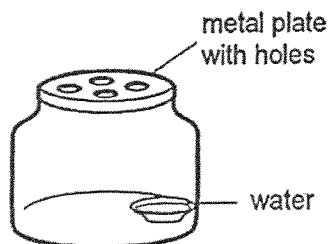

2 Which statement is not true about animals?

- (1) They can grow.
- (2) They can reproduce.
- (3) They can respond to changes.
- (4) They can make their own food.

3 The diagram shows a painting hanging on a wall.

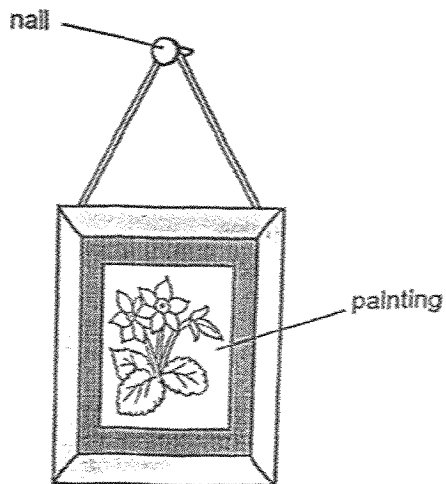

Iron is used to make nails because iron _____.

- (1) is shiny
- (2) is flexible
- (3) is strong
- (4) conducts heat quickly

4 A, B, C and D are the various stages in the life cycle of a butterfly.

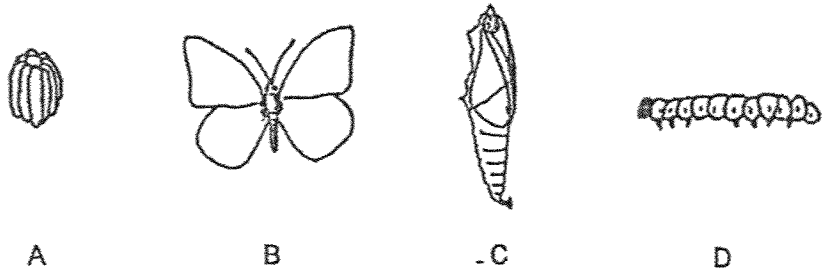

Which of the following shows the correct order of the stages?

(1)

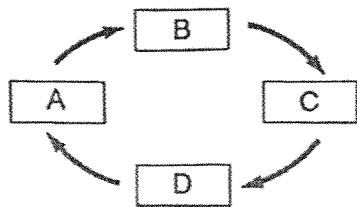

(2)

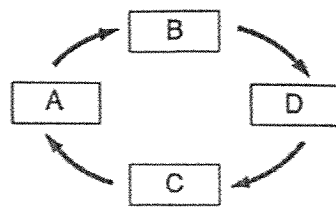

(3)

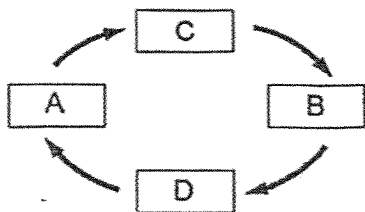

(4)

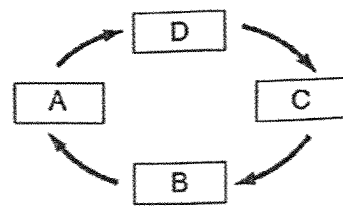

- 5 The diagram shows the life cycle of a plant.

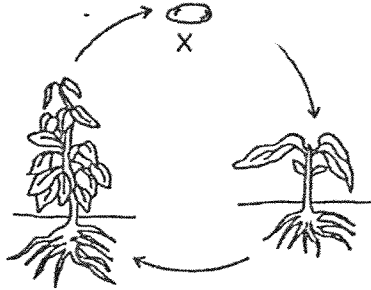

What is the stage marked X?

- (1) fruit
 - (2) seed
 - (3) seedling
 - (4) adult plant
- 6 Which of the following is a correct function of the root?
- (1) holds plant firmly to the soil
 - (2) keeps the plant upright
 - (3) makes food for the plant
 - (4) carries food and water to the leaves
- 7 In which part of the digestive system is food absorbed into the blood?
- (1) mouth
 - (2) stomach
 - (3) small intestine
 - (4) large intestine

- 8 The diagram shows a magnet brought near a glass block.



What will happen to the glass block?

- (1) It will move up.
 - (2) It will not move.
 - (3) It will move to the left.
 - (4) It will move to the right.
- 9 Which one of the following is not a source of heat?

- (1) The Sun
- (2) A lighted bulb
- (3) A woollen cap
- (4) A candle flame

10

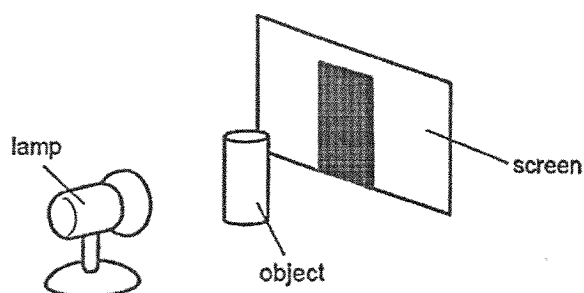

The shadow of the object is formed on the screen because _____.

- (1) the object blocks light
- (2) the screen absorbs light
- (3) the object reflects light
- (4) the screen gives off light

11 Study the flowchart below.

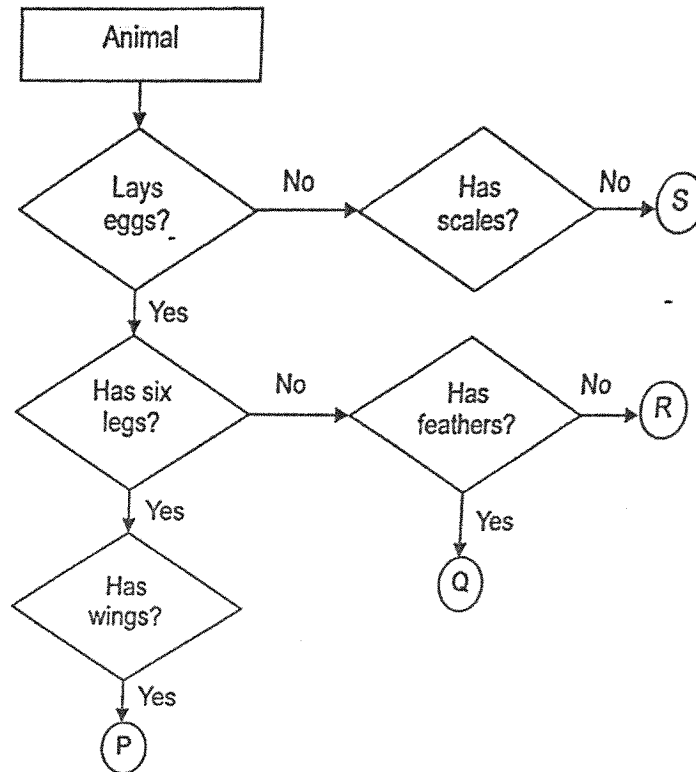

Based on the flowchart given, which of the following are likely to be correct?

- A. P is an insect.
- B. Q is a bird.
- C. S gives birth to its young alive.

- (1) A and B only
- (2) B and C only
- (3) A and C only
- (4) A, B and C

12 Which of the following statements are correct?

- A: Ferns can make their own food.
- B: Mushrooms can make their own food.
- C: Micro-organisms cannot be seen with the naked eye.
- D: Bacteria do not respond to changes in the surroundings.

- (1) A and C only
- (2) B and C only
- (3) A, B and D only
- (4) A, B, C and D

13 The table below shows the characteristics of three living things X, Y and Z.

Living Thing	Can make their own food	Can move freely from place to place
X	No	Yes
Y	Yes	No
Z	No	No

Which one of the following is correctly classified as plants, animals and fungi?

	Plants	Animals	Fungi
(1)	X	Y	Z
(2)	Y	X	Z
(3)	Y	Z	X
(4)	Z	X	Y

- 14 Christine wanted to find out which material, W, X, Y or Z, is waterproof. She placed 4 similar strips of the materials, into a basin of blue-coloured water for 10 minutes. Christine recorded her observations as shown in the diagram below.

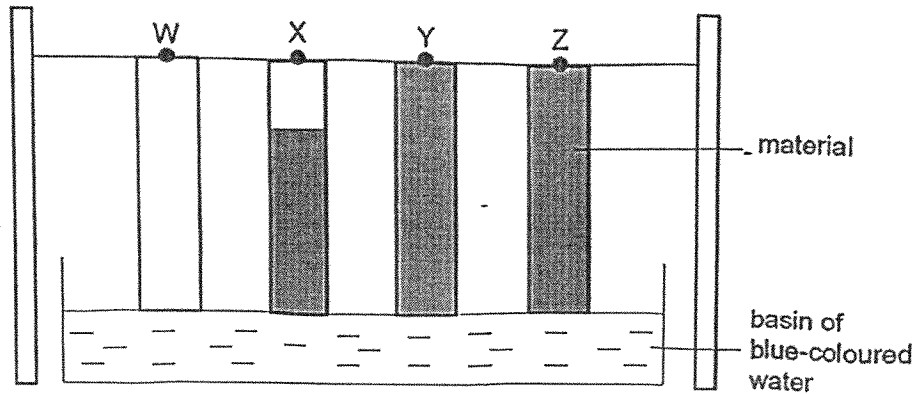

Based on the information above, which of the following shows the most suitable material to make a raincoat, a towel and a cup?

	Raincoat	Bath Towel	Floor Tile
(1)	Z	W	Y
(2)	W	X	Z
(3)	Y	X	Z
(4)	W	Z	W

- 15 The classification table shows how matter can be grouped.

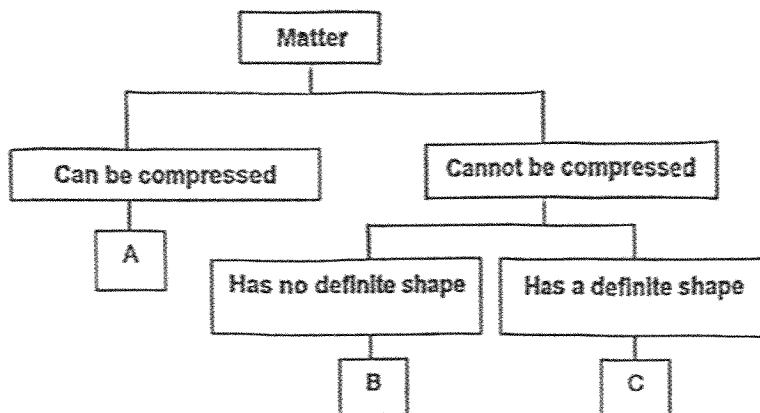

Which of the substances below would correctly represent A, B and C above?

	A	B	C
(1)	Pebble	Carbon dioxide	Water
(2)	Oxygen	Air	Water
(3)	Water vapour	Water	Pebble
(4)	Water	Water vapour	Pebble

16 Mr Lim uses the following tool to dig some soil in his garden.



Which material would be most suitable to make part X?

- (1) glass
- (2) rubber
- (3) metal
- (4) plastic

- 17 Look at the diagram of a pair of rain boots below. They are used by the workers at a construction site.



Which of the following properties would be important when making the rain boots?

- A flexible
- B waterproof
- C able to float

- (1) B only
- (2) A and B only
- (3) B and C only
- (4) A, B and C

- 18 Jane carried out an experiment on 4 different types of materials A, B, C and D. She placed a few drops of water on each material and observed the material.

Material	Observation
A	The water seeped into the material after some time.
B	The water flowed off the sides of the material.
C	The water was absorbed into the material immediately.
D	Each drop of water remained on the surface of the material.

Based on the information above, which of the four materials, A, B, C and D is/are suitable to be used to make hand towels?

- (1) D only
- (2) A and C only
- (3) B and C only
- (4) A, B and C only

19 Samantha had four magnets, A, B, C and D, as shown below.



Magnet A



Magnet B



Magnet C



Magnet D

She brought each of them 5 cm away from a box of pins and observed the number of pins attracted by each magnet. She recorded her observations in the table below.

	Magnet A	Magnet B	Magnet C	Magnet D
Number of pins attracted	35	25	40	30

Based only on Samantha's results, she can conclude that _____.

- (1) the size of the magnet affects its strength
- (2) bigger magnets are weaker than smaller magnets
- (3) smaller magnets are weaker than bigger magnets
- (4) the strength of a magnet does not depend on its size

20 Hazid set up the experiment as shown below.

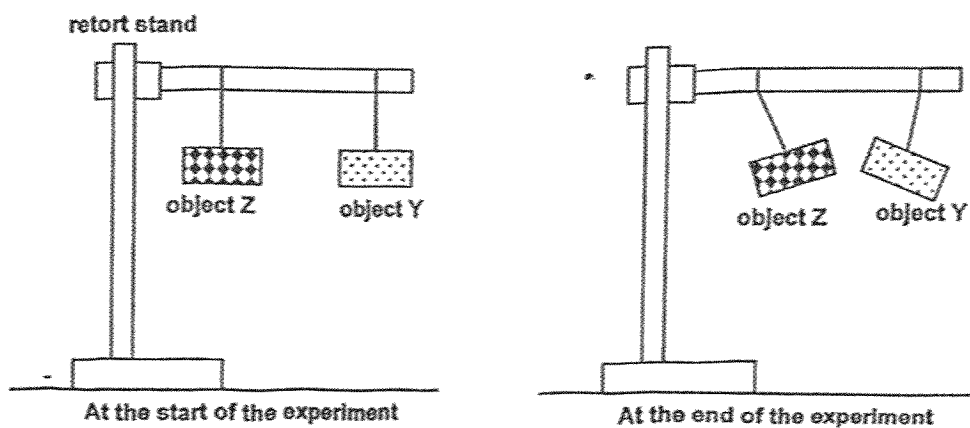

Based only on Hazid's experiment, which of the following statements are likely to be correct?

- A Object Z is made of copper.
- B Object Y is a magnetic material.
- C Magnetism can act from a distance.

- (1) A and B only
- (2) A and C only
- (3) B and C only
- (4) A, B and C

- 21 Four metal bars, A, B, C and D are hung from a wooden rod as shown in the diagram below. The two ends of each metal bar are marked X and Y respectively. The North pole of a bar magnet is brought near X and then Y of each metal bar.

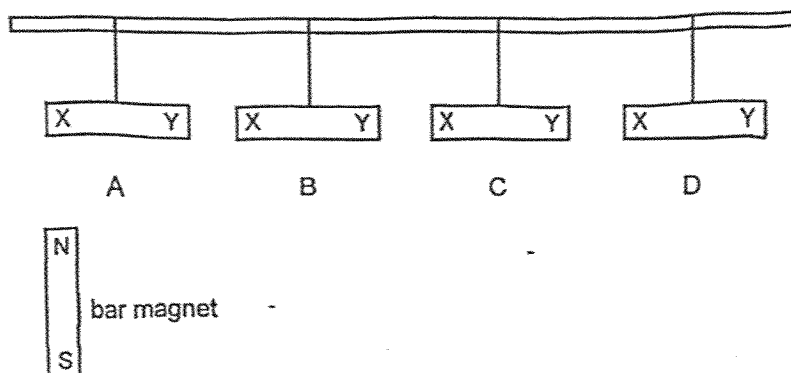

The observations made during the experiment are recorded in the table below.

Metal bar	North pole and End X	North pole and End Y
A	Not attracted	Not attracted
B	Attracted	Attracted
C	Repelled	Attracted
D	Attracted	Attracted

Which one of the following conclusions about the experiment is correct?

- (1) Bars B and D are made of iron.
- (2) Bar A is made of a magnetic material.
- (3) All the metal bars are made of magnetic materials.
- (4) Bar A is a weak magnet and Bar C is a strong magnet.

22 Ricky drew up a flowchart as shown below to classify 5 different things.

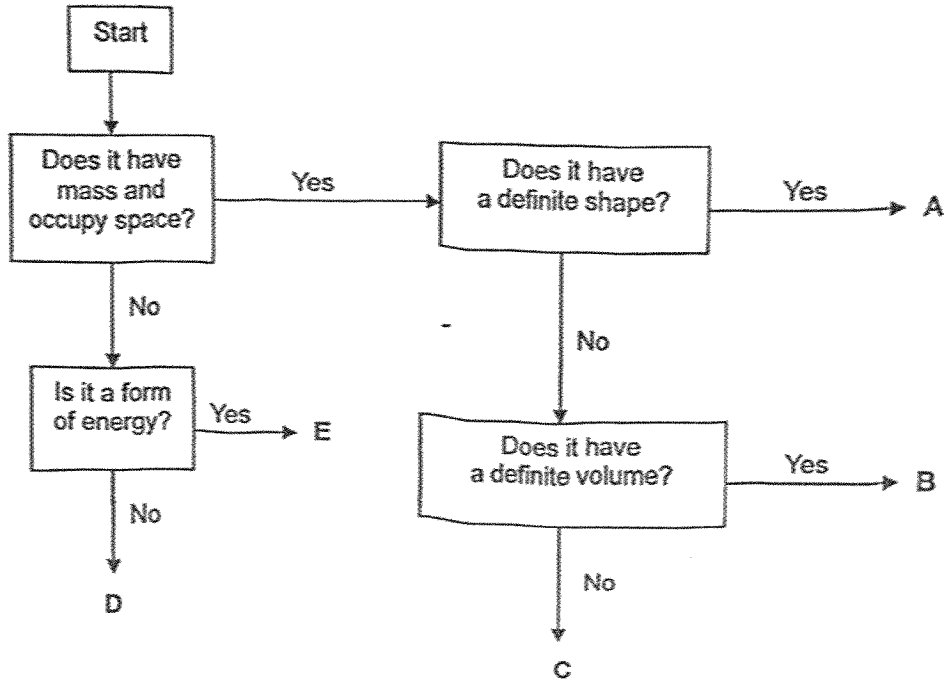

Which one of the following is correct?

Things				
	A	B	D	E
(1)	ice	powder	sound	heat
(2)	plasticine	gel	light	shadow
(3)	sand	water	shadow	light
(4)	rock	flour	heat	sound

- 23 Matthew used a hand pump to pump more air into the basketball shown below. He observed that the size of the basketball remained the same.

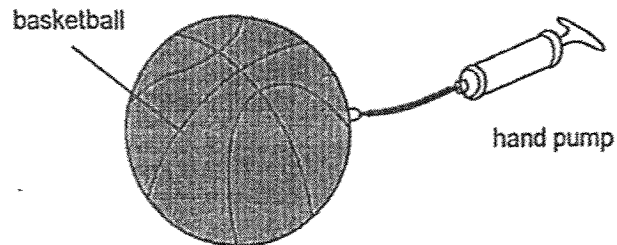

Which of the following correctly shows the change (if any) in the mass and volume of air in the basketball?

	mass	volume
(1)	increase	increase
(2)	increase	no change
(3)	no change	increase
(4)	no change	no change

24 The diagram below shows 4 identical glass containers, P, Q, R and S, each containing different substances.

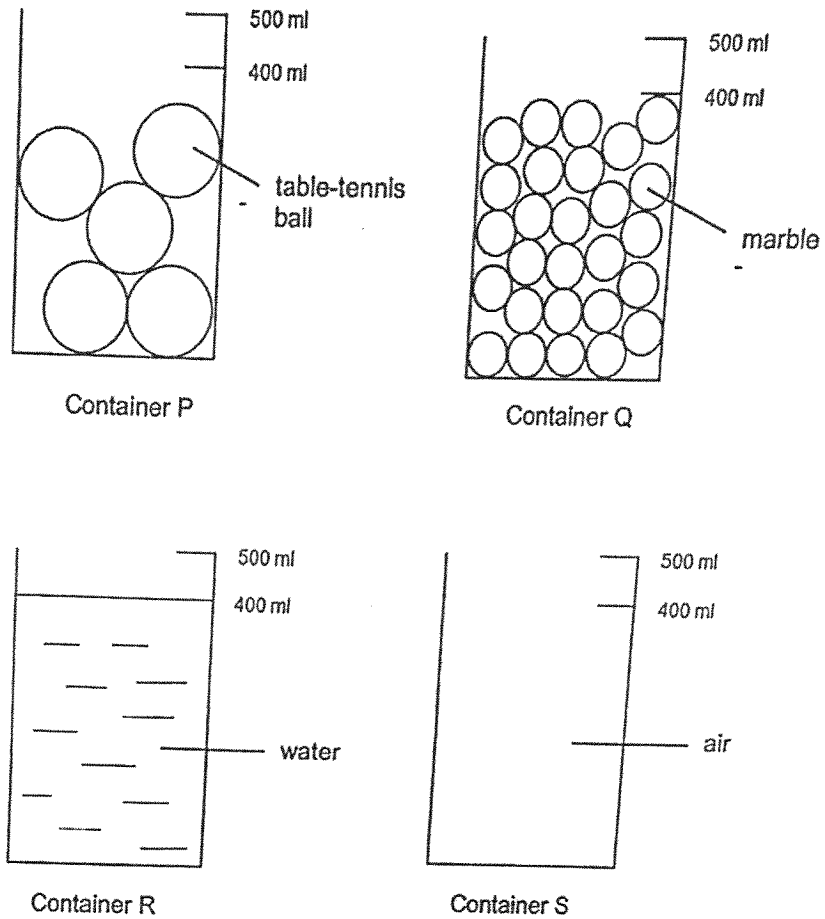

A jug containing 1 litre of water is poured into each container at the same time. The water is poured at the same rate.

Which one of the following correctly shows the order in which the water will overflow, from the fastest to the slowest?

	fastest	→			slowest
(1)	P	R	S	Q	
(2)	R	Q	P	S	
(3)	S	P	Q	R	
(4)	Q	P	R	S	

- 25 Susan's teacher set up the apparatus as shown in the diagram below. When she poured water into the funnel, it did not flow into the flask.

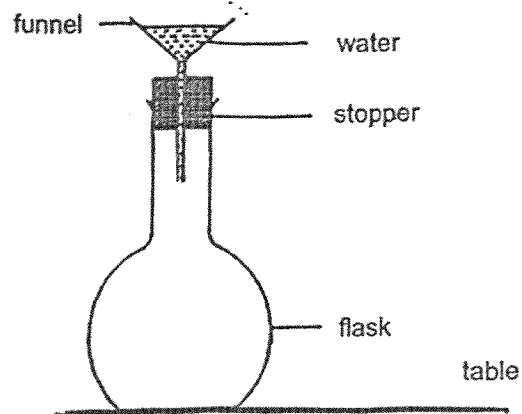

Susan then set up the same apparatus. When she poured water into the funnel, she found that it could flow into the flask.

Which one of the following had caused her result to be different from that of her teacher?

- (1) Susan poured the water in quickly.
- (2) The water Susan used was cold water.
- (3) The stopper in Susan's set-up was loose.
- (4) Susan did the experiment on a cooler day.

- 26 A glass of hot water at 85°C is placed into a basin of tap water at 30°C as shown in the diagram below.

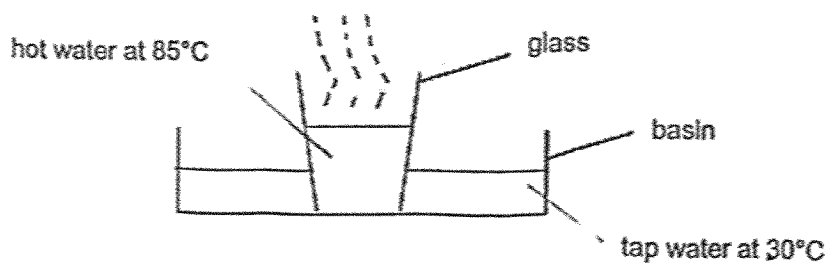

What would be the temperature of the water in the glass and the temperature of the water in the basin after 5 minutes?

	Temperature of water in the glass ($^{\circ}\text{C}$)	Temperature of water in the basin ($^{\circ}\text{C}$)
(1)	90	25
(2)	85	30
(3)	75	35
(4)	70	30

27 Julie placed a pot of hot soup on a table with a plastic top.

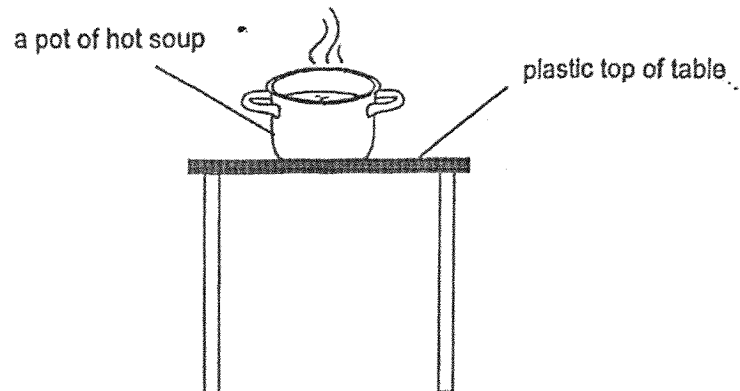

If Julie wants the soup to cool down more quickly, which of the following should she do?

- A Keep the pot in a big wooden box.
- B Wrap the pot with a piece of dry cloth.
- C Wrap the pot with a piece of wet cloth.
- D Place the pot on a piece of aluminium sheet.

- (1) A and B
- (2) A and C
- (3) B and D
- (4) C and D

28 Raju had an experimental set-up as shown below.

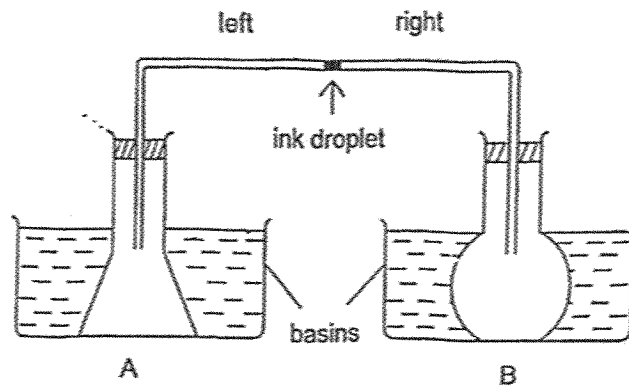

He wanted the ink droplet to move to the left.

Which one of the following actions should he carry out?

- (1) Heat the water in basin A and B.
- (2) Cool the water in basin A and B.
- (3) Heat the water in basin A but cool the water in basin B.
- (4) Cool the water in basin A but heat the water in basin B.

- 29 Wei Ming turns on the lamp in his room at night and saw his toy on the table as shown in the diagram below.

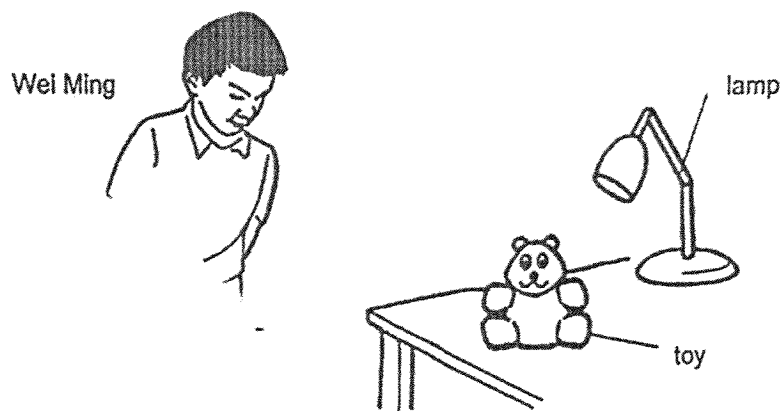

Which one of the following correctly shows the path of light that makes it possible for Wei Ming to see the toy on the table?

- (1) From lamp to Wei Ming to toy
- (2) From lamp to toy to Wei Ming
- (3) From toy to Wei Ming to lamp
- (4) From toy to lamp to Wei Ming

- 30 The diagrams below show three shapes, a square, a triangle and a circle, each made of a different material.

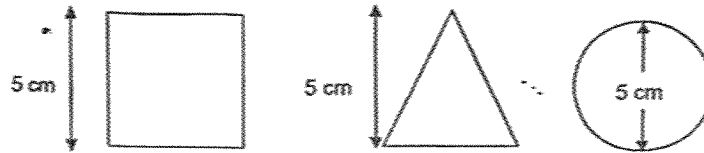

The diagram below shows the side view of the three shapes hung at different positions, A, B and C.

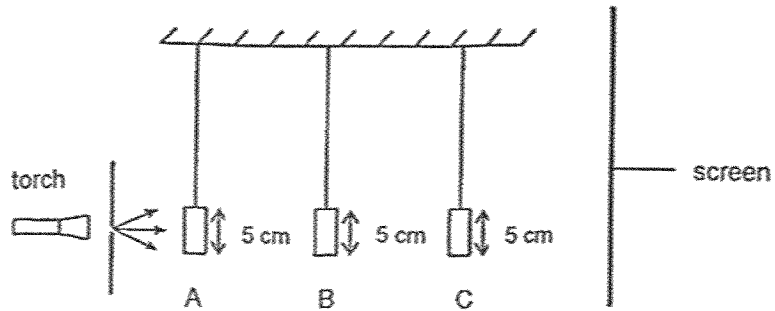

The shadows cast on the screen are shown below.

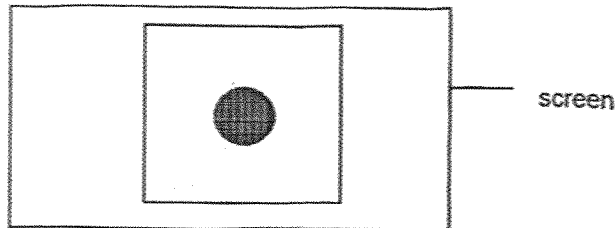

Which one of the following correctly shows the positions of the shapes?

	Position A	Position B	Position C
(1)	circle	triangle	square
(2)	square	circle	triangle
(3)	triangle	square	circle
(4)	triangle	circle	square

End of Booklet A

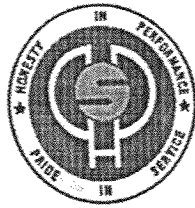

HENRY PARK PRIMARY SCHOOL
2025 END OF YEAR EXAMINATION
STANDARD SCIENCE
PRIMARY FOUR
BOOKLET B

Name: _____ ()

Class: Primary 4 ()

12 QUESTIONS

40 MARKS

TOTAL TIME FOR BOOKLETS A & B: 1 HOUR 45 MINUTES

INSTRUCTIONS TO CANDIDATES

1. Do not turn over this page until you are told to do so.
2. Follow all instructions carefully.
3. Answer all questions.

Marks for Booklet B: _____ / 40

Booklet B

Write your answers to questions 31 to 42 in the spaces given.
The number of marks available is shown in the [] at the end of each question or part question.

(40 marks)

- 31 Su Mei saw two things shown in the diagram below.



Circle the correct answer.

- a) A dog is a living thing because it (can / cannot) move and (can / cannot) respond to changes around it. [1]
- b) A ball is a non-living thing because it (can / cannot) grow and (can / cannot) reproduce. [1]

32 Study the classification chart below.

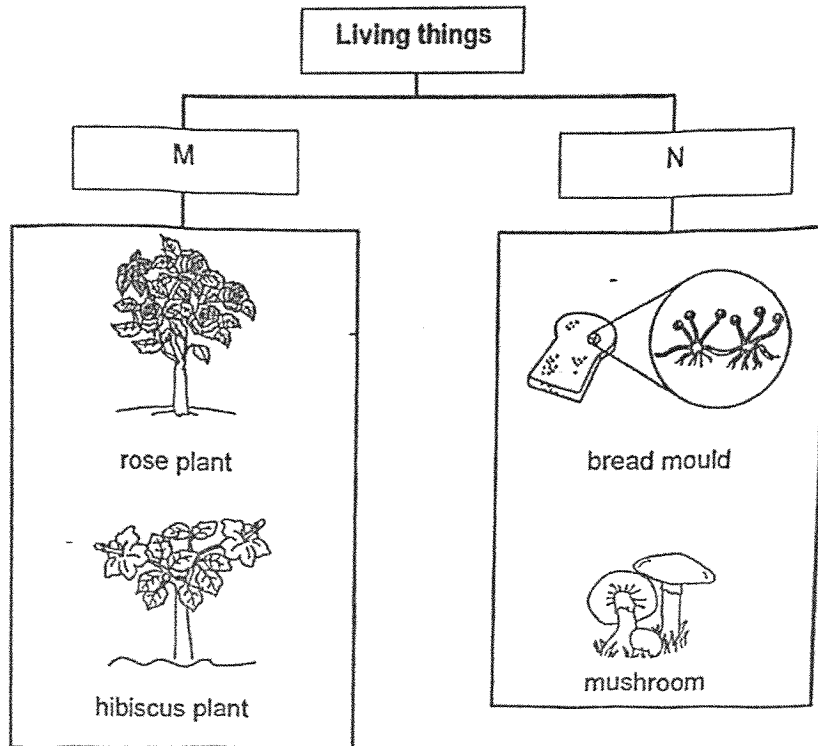

Choose the correct words from the box to give suitable headings for M and N.

flowering plants	non-flowering plants	fungi	bacteria
------------------	----------------------	-------	----------

M- _____

[1]

N- _____

[1]

- 33 R and S are two animals in the chart below.

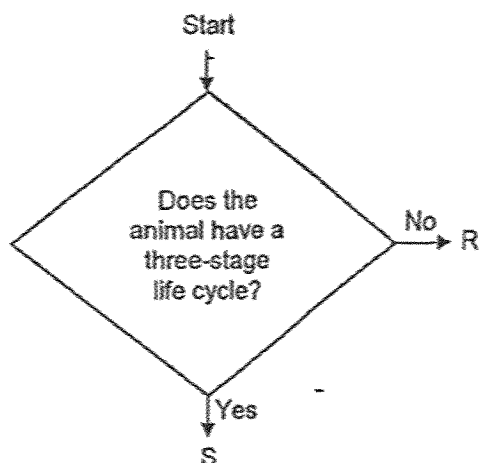

Read the following statements and tick (✓) the true / false box.

[3]

	True	False
a) Both animals R and S have a three-stage life cycle.		
b) Animal R can be a grasshopper.		
c) Animal S can be a frog.		

- 34 Draw lines to match each state of matter correctly to its properties.

[3]

State of matter		Properties
liquid	●	no definite volume no definite shape
gas	●	no definite volume definite shape
solid	●	definite volume no definite shape
		definite volume definite shape

35 Sam observed object X closely and wrote down the following properties.

Property of object X	Yes	No
can be stretched		✓
breaks easily	✓	
allow light to pass through	✓	
absorbs water		✓

a) What material is object X possibly be? [1]

b) State one use of object X. [1]

c) Sam blew a balloon as shown in the diagram below. He observed that the balloon increased in size as more air was blown.



(i) State the property of air that can be observed in this experiment. [1]

(ii) Rubber is commonly used as material Y to make balloons. [1]

Explain why rubber is used.

- 36 Stacey wanted to see how the length of a magnet affects the magnetic strength of the magnet. She prepared two set-ups, A and B, as shown in the diagram below.

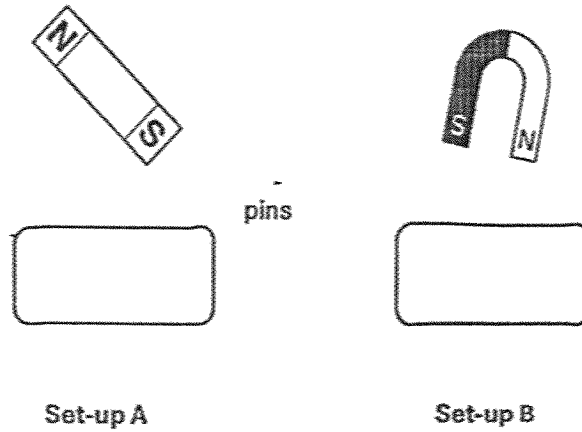

- a) What should Stacey do to find out which magnet is stronger? [2]

- b) Stacey's teacher said that she did not set up a fair test. Do you agree? Explain your answer. [1]

- c) State one property of the pins that make them suitable for this experiment. [1]

- 37 Ahmad walked in a straight line from P to R as shown below. At Q, he was directly under the lamp. The distance between P and Q is the same as the distance between Q and R.

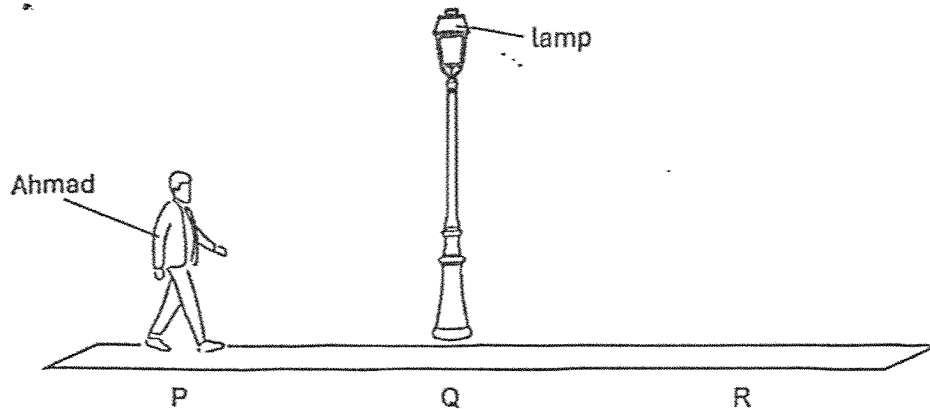

The graph shows how the length of Ahmad's shadow on the ground changed during his walk.

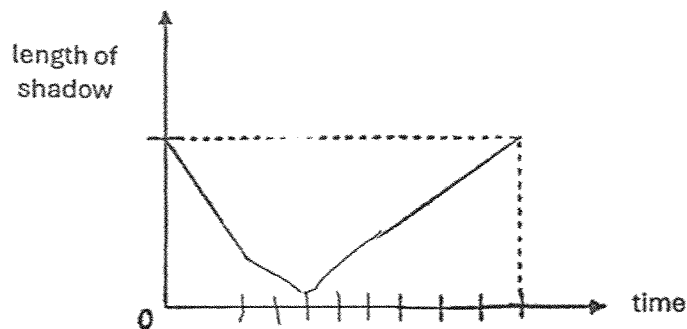

Two properties of light caused shadows to be formed.

One of these is light travels in a straight line.

- (a) State the other property of light.

[1]

- (b) Was Ahmad walking at a faster or slower speed from Q to R compared to when he was walking from P to Q? Explain your answer.

[2]

38 The table below shows different types of items and their properties.

Item	Properties of matter		
	Has Mass	Has definite shape	Has definite volume
fruit juice		X	✓
story book		✓	X
honey		✓	✓
oxygen		X	X

a) In the table below, name the items that have been wrongly classified above and give a reason why they are wrongly classified. [2]

	Item wrongly classified	Reason
(i)		
(ii)		

Jane poured the same amount of substance X into three containers (A, B and C) as shown below.

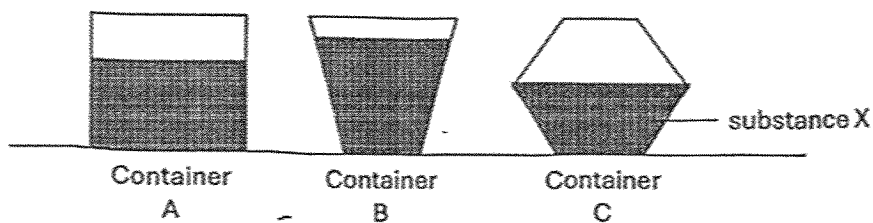

b) State two properties of substance X that can be observed from the above set-ups [2]

- 39 Mrs Lee baked an ice cream dessert shown below for 10 minutes. The ice cream did not melt when it was first taken out of the oven.

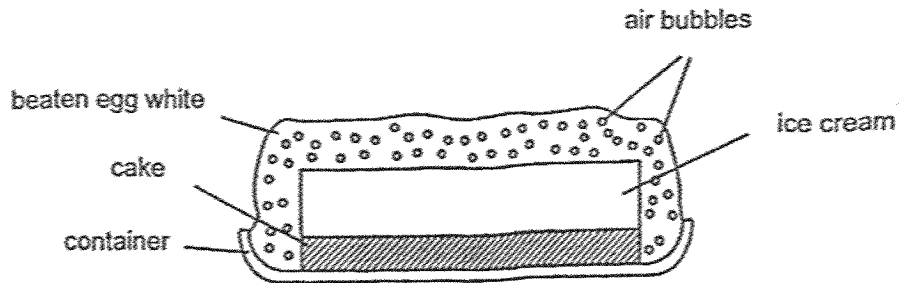

- a) How did using a metal container instead of a wooden container shorten the baking time of the cake? [2]

- b) Why did the ice cream not melt when it was first taken out of the oven? [1]

- c) The ice cream would eventually melt. Give a reason for this. [1]

- 40 Marsha did an experiment to compare the expansion of 2 different liquids, X and Y. She filled one flask with liquid X and another with liquid Y. The levels of the liquids in the glass tubes were the same.

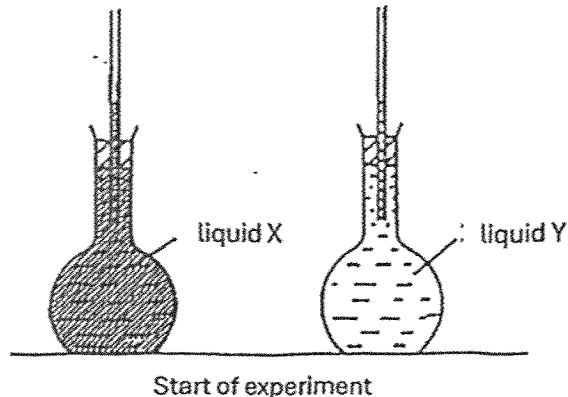

Start of experiment

The flasks were then placed in a container of hot water. After some time, the liquids rose in the tubes as shown in the diagram below.

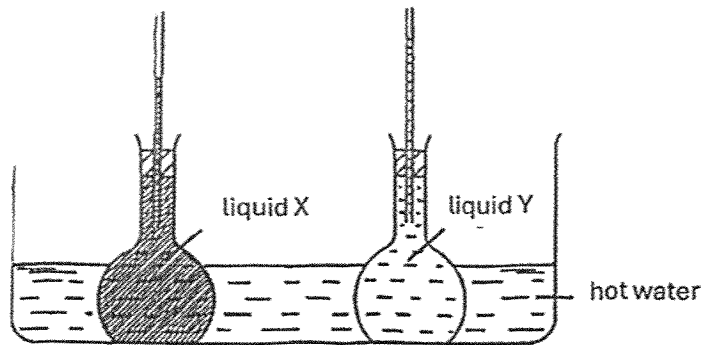

End of experiment

- a) Why were the flasks placed in hot water? [1]
-
- b) What conclusion could Marsha make from her experiment about liquids X and Y? [1]
-
- c) If the levels of the liquids in the glass tubes were not the same at the start of the experiment, how could Marsha compare the expansion of liquids X and Y? [2]
-
-

- 41 John conducted an experiment in a dark room to measure the amount of light that can pass through four different materials, P, Q, R and S. He used a torch that gives out 500 units of light.

The four different materials, P, Q, R and S, were of the same thickness and placed between the torch and the light sensor connected to a data logger as shown below.

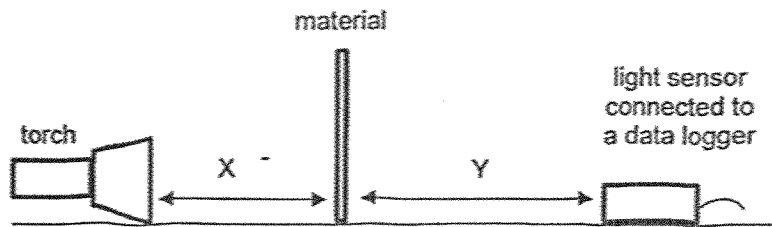

The amount of light that was detected by the data logger was shown in the table below.

Material	P	Q	R	S
Amount of light detected (units)	480	250	90	0

- a) Why did John have to conduct his experiment in a dark room? [1]

- b) Why did John have to keep distances X and Y the same for all the materials that he tested? [1]

- c) Which one of the materials, P, Q, R or S, is the most suitable for making a fish tank so that people can enjoy looking at the fish swimming in the tank? [2]
Give a reason for your answer.

- 42 The diagram shows a heater placed at the same distance from 2 identical metal containers A and B. Container A was wrapped with a layer of wool.

Both containers were filled with water at room temperature at the start of the experiment.

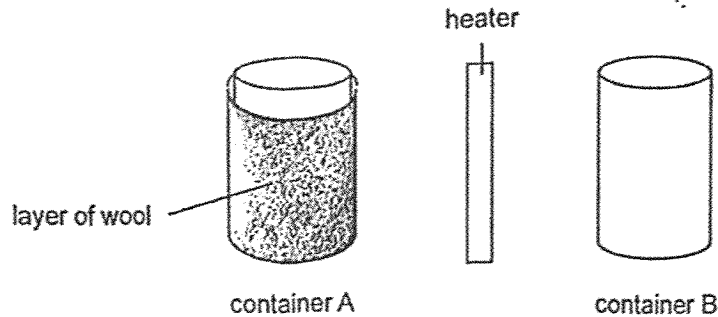

Mabel measured and recorded the changes in the temperature of water in both containers over time. The results are shown in the graph below.

- a) Using the boxes given, label the two graphs with letters A and B to indicate the changes in the temperature of the water in each container as time passes. [1]

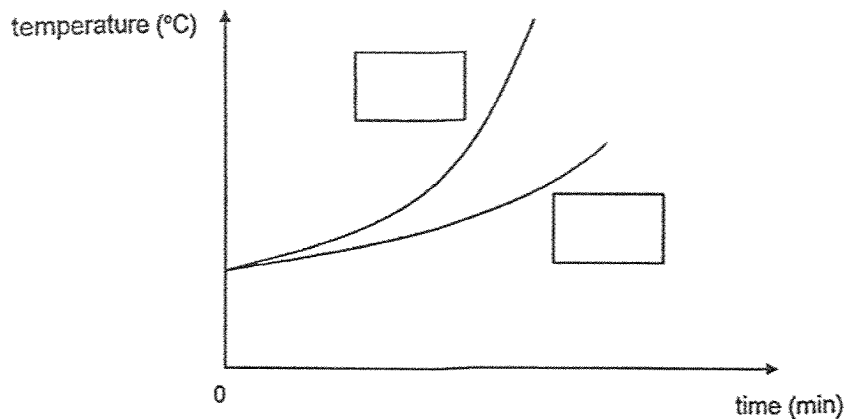

- b) Explain your answer in (a) clearly. [2]

End of Booklet B

SCHOOL : HENRY PARK PRIMARY SCHOOL
LEVEL : PRIMARY 4
SUBJECT : SCIENCE
TERM : 2025 END OF YEAR EXAMINATION

Q1	Q2	Q3	Q4	Q5	Q6	Q7	Q8	Q9	Q10
3	4	3	4	2	1	3	2	3	1
Q11	Q12	Q13	Q14	Q15	Q16	Q17	Q18	Q19	Q20
4	1	2	4	3	3	2	2	4	3
Q21	Q22	Q23	Q24	Q25	Q26	Q27	Q28	Q29	Q30
1	3	2	2	3	3	4	4	2	2

31a	can, can
31b	cannot, cannot
32	M – flowering plants N – fungi
33	a) False b) False c) True
34	<div style="display: flex; justify-content: space-around;"> <div style="text-align: center;"> <p>State of matter</p> <div style="display: flex; flex-direction: column; gap: 10px;"> <div style="border: 1px solid black; padding: 5px; width: 150px; height: 40px; margin: 0 auto;">liquid</div> <div style="border: 1px solid black; padding: 5px; width: 150px; height: 40px; margin: 0 auto;">gas</div> <div style="border: 1px solid black; padding: 5px; width: 150px; height: 40px; margin: 0 auto;">solid</div> </div> </div> <div style="text-align: center;"> <p>Properties</p> <div style="display: flex; flex-direction: column; gap: 10px;"> <div style="border: 1px solid black; padding: 5px; width: 150px; height: 40px; margin: 0 auto;">no definite volume no definite shape</div> <div style="border: 1px solid black; padding: 5px; width: 150px; height: 40px; margin: 0 auto;">no definite volume definite shape</div> <div style="border: 1px solid black; padding: 5px; width: 150px; height: 40px; margin: 0 auto;">definite volume no definite shape</div> <div style="border: 1px solid black; padding: 5px; width: 150px; height: 40px; margin: 0 auto;">definite volume definite shape</div> </div> </div> </div>
35a	
35b	X can be used to make spectacle lens / a beaker
35c(i)	Air takes up space / can be compressed / has no definite volume.

35c(ii)	Rubber can be stretched / is flexible / is waterproof.
36a	Place each magnet close to paper clips and observe which magnet attracts more pins.
36b	Agree – There can only be one changed variable which is the length of magnet.
36c	It is made of a magnetic material
37a	Light cannot pass through opaque materials / objects
37b	Slower. The increase in length of shadow takes place over a longer period of time compared to the decrease in his shadow.
38a	Honey – no definite shape as it is a liquid Story book – definite volume as it is a solid
39a	Metal is a better conductor of heat and so the cake gains heat more quickly.
39b	The air in the bubbles is a poor conductor of heat.
39c	The ice cream gains heat from the surrounding air.
40a	The hot water provided heat for the liquids to expand
40b	Liquid Y expands faster / more than liquid X.
40c	She could record the difference in the level of liquids in each glass tube and then compare the difference in the levels after the expansion.
41a	The light comes only from the torch.
41b	It is to ensure that the light detected by the data logger is only due to the transparency of each material.
41c	Material P. It allows the most light to pass through it.
42a	
42b	The layer of wool covering container A traps air which is a poor conductor of heat. Thus, the water in container A will take a longer time to gain heat from the heater as compared to the water in container B.